

# E09

## D - SUB PCB RIGHT ANGLE (7.2mm) FOOTPRINT : (0.318")

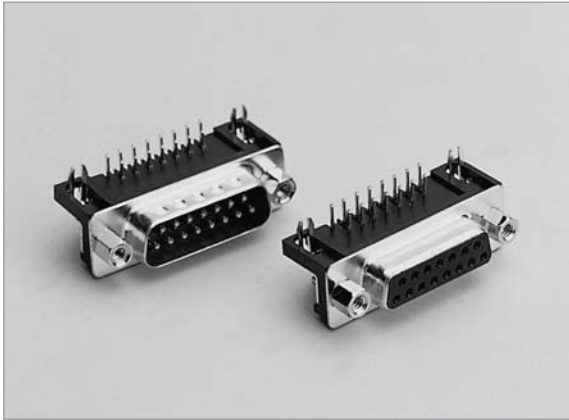

POSITION	A	B	C
9F	16.30	25.00	30.8
15F	24.60	33.30	39.2
23F	35.30	44.30	50.3
25F	38.30	47.10	53.1
37F	54.80	63.50	69.4

POSITION	A	B	C
9M	16.92	25.00	30.8
15M	25.25	33.30	39.2
23M	35.90	44.30	50.3
25M	38.96	47.10	53.1
37M	55.42	63.50	69.4

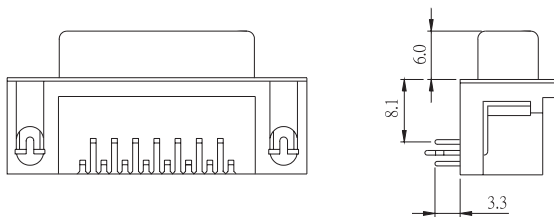
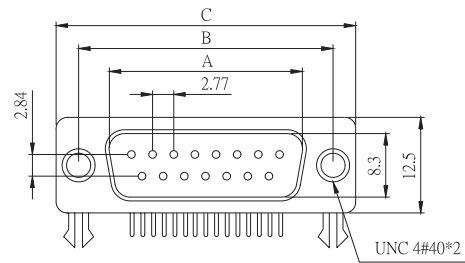
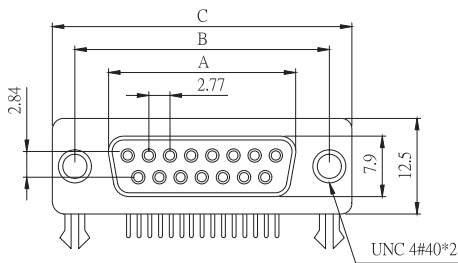

FEMALE

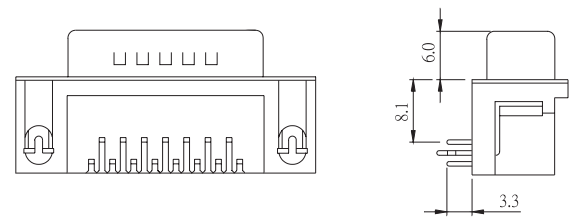

MALE

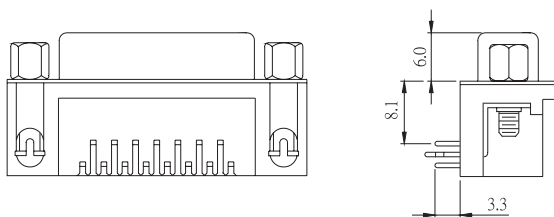
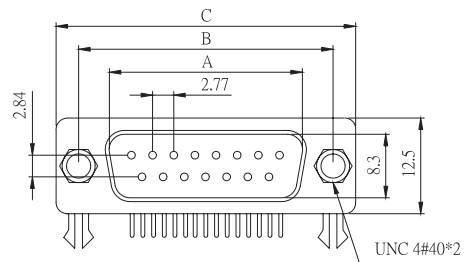
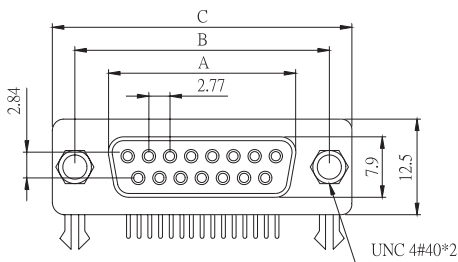

FEMALE

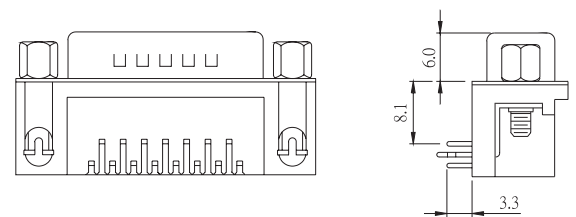

MALE



# E09

## D - SUB PCB RIGHT ANGLE (7.2mm) FOOTPRINT : (0.318")

### PROCESS OPTION

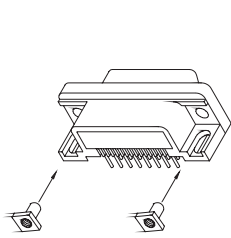

W/RIVET ONLY

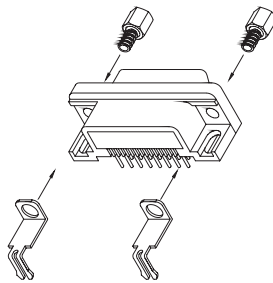

W/BOARDLOCK  
SCREW FIXED

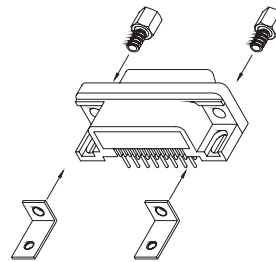

W/NON-THREAD L-SHAPE  
SCREW FIXED

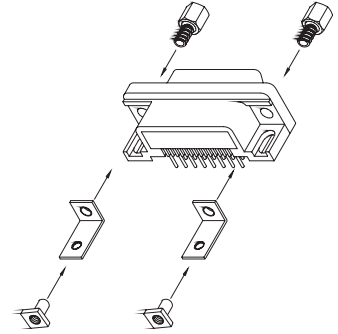

RIVET W/NON-THREAD  
L-SHAPE SCREW FIXED

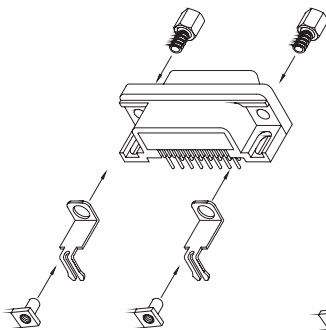

RIVET W/BOARDLOCK  
SCREW FIXED

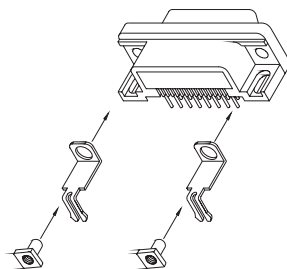

RIVET W/BOARDLOCK

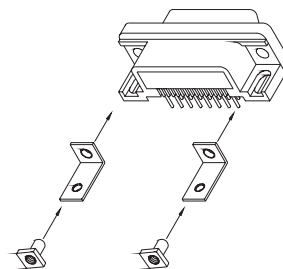

RIVET W/NON-THREAD  
L-SHAPE

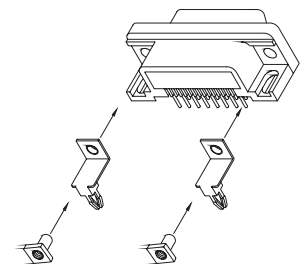

RIVET W/4-PRONG  
BOARDLOCK

### HOW TO ORDER:

E09 -  1 -  2 -  3 -  4 -  5 -  6 -  7 -  8

1.NO. OF CONTACT	2.CONTACT TYPE	3.CONTACT PLATING	4.SHELL PLATING
09 15 23 25 37	M: MALE F: FEMALE	T: TIN PLATED S: SELECTIVE G: GOLD FLASH A: 5u" INCH GOLD B: 10u" INCH GOLD C: 15u" INCH GOLD D: 30u" INCH GOLD	T: TIN N: NICKEL P:TIN + DIMPLE Q: NICKEL + DIMPLE Z: ZINC (CHROMATIC)
5.MOUNTING METHOD	6.ACCESSORIES	7.SPECIAL OPTION	8.INSULATOR COLOR
A: BOARDLOCK (Z - SHAPE) B: RIVET W/BOARDLOCK (Z - SHAPE) C: RIVET ONLY D: NON - THREAD L - SHAPE E: RIVET W/NON - THREAD L - SHAPE F: 4#40 THREAD L - SHAPE G: RIVET W/4#40 THREAD L - SHAPE T: 4 - PRONG BOARDLOCK U:RIVET W/4 - PRONG BOARDLOCK	A: NON ACCESSORIES B: ADD SCREW (4.8 * 11.8) C: FIX SCREW (4.8 * 11.8) D: ADD SCREW (5.8 * 12.0) E: FIX SCREW (5.8 * 12.0)	A: STANDARD TYPE B: EMI TYPE	1. BLACK

E